

**PRODUCT INFORMATION**EIGHT STEPS TO SELECTING A PRESSURE,  
DIFFERENTIAL PRESSURE OR TEMPERATURE SWITCH

Ashcroft offers several different pressure, differential pressure and temperature switch models. This guide will help you select the best model for your application. In many cases there may be more than one choice, so the lower cost option is usually the best choice. As a guideline a NEMA 7 rated switch will cost more than a NEMA 4 rated switch. A Stainless Steel housing will cost more than a die cast Aluminum or Brass housing. A dual chamber design more than the standard housing.

**The Eight Steps:**

1. Does the applications require an Explosion Proof (NEMA 7) housing or a Watertight (NEMA 4) housing?
2. Do you need single or dual set points?
3. Do you need fixed or adjustable dead band?
4. Do you need an adjustable set point switch or a factory set only switch (this step is only for Pressure Switches)?
5. Select the appropriate switch model listed in the step 5 boxes in the pressure, differential pressure or temperature switch selection charts. This selection would be based on comparing the basic size and features of the switch models listed in the box based on your choices for the first 4 steps. Refer to the appropriate switch product matrix or catalog page for more information on the switch models.
6. Determine the operation range needed from the appropriate switch model range charts.
7. Select the appropriate micro switch based on your electrical requirements and dead band requirements.
8. Select the wetted materials and process connection based on your process media and piping.

At this point you should be able to build the appropriate switch part number by following the "How to order this switch" section on the appropriate catalog page. Additional switch options should also be added to the part number.

STEP NUMBER

PRESSURE SWITCH SELECTION

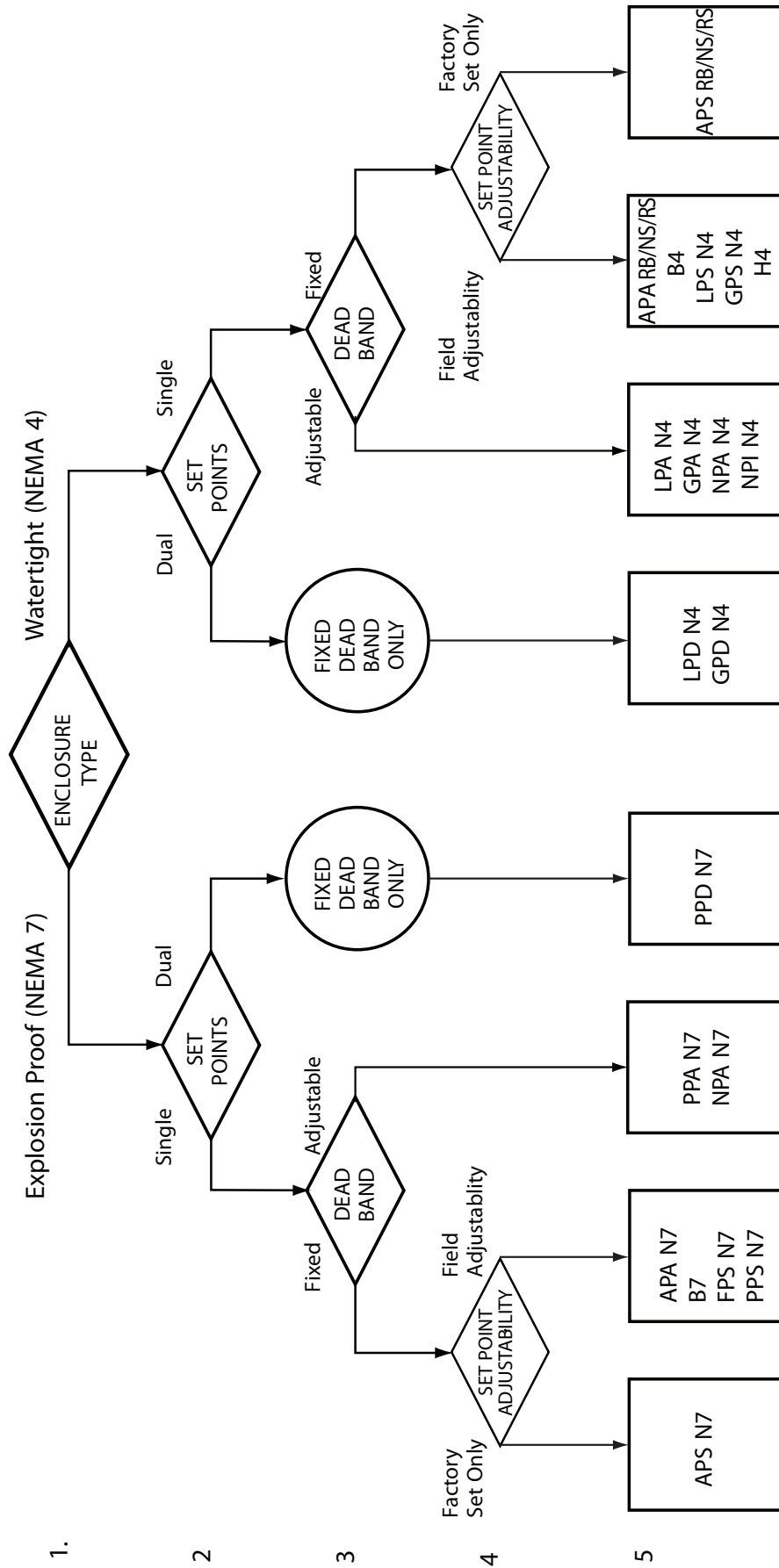

6. Determine the operation range needed from the appropriate switch model range charts.
7. Select the appropriate micro switch based on your electrical requirements and dead band requirements.
8. Select the wetted materials and process connection based on your process media and piping.

At this point you should be able to build the appropriate switch part number by following the "How to order this switch" section on the appropriate catalog page. Additional switch options should also be added to the part number.





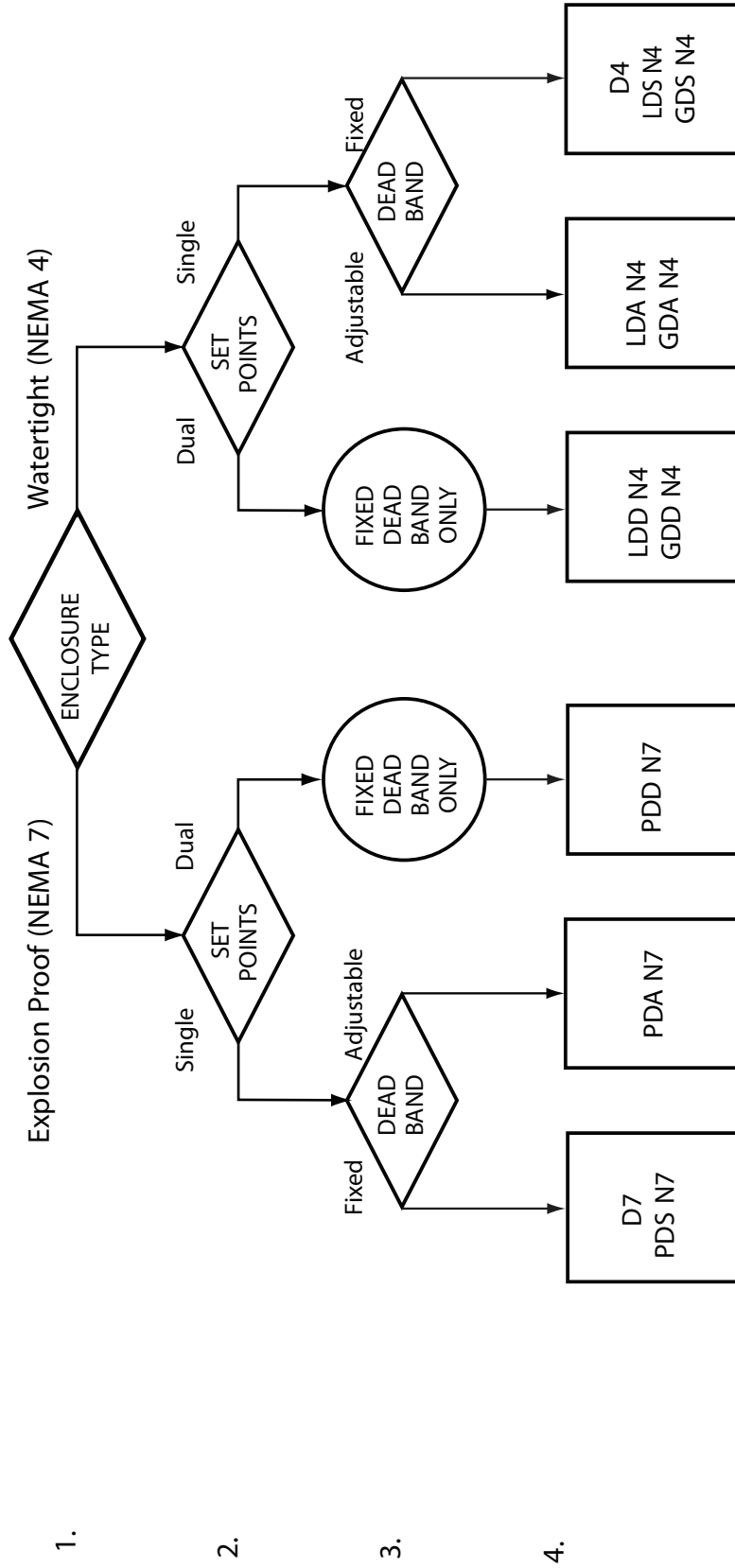

STEP  
NUMBER

DIFFERENTIAL PRESSURE SWITCH SELECTION



- 1.
  - 2.
  - 3.
  - 4.
  5. Determine the operation range needed from the appropriate switch model range charts.
  6. Select the appropriate micro switch based on your electrical requirements and dead band requirements.
  7. Select the wetted materials and process connection based on your process media and piping.
- At this point you should be able to build the appropriate switch part number by following the "How to order this switch" section on the appropriate catalog page. Additional switch options should also be added to the part number.

# DIFFERENTIAL PRESSURE SWITCH PRODUCT MATRIX

		ENCLOSURE / PROCESS INPUT					CONTROL FUNCTION				SWITCH TYPE						WETTED MATERIAL												RANGES									
		Watertight (NEMA 4)	Explosion Proof (Nema 7)	Stainless Steel Body	Pressure	Differential Pressure	Temperature	Single Fixed Setpoint	Single Adjustable Setpoint	Adjustable Deadband	Two Indep. Adjust. Setpoints	Fixed Deadband	General Purpose	Narrow Deadband	Hermetically Sealed	Manual Reset	Relay	DPT	Buna	Viton	Teflon	Stainless Steel	Monel	Compound Inches of Water	Inches of Water	Compound	0-400 psi	0-600 psi	1000 psi	2000 psi	3000 psi	4000 psi	5000-20,000 psi	-40 - 750°F				
		✓	✓	✓		✓	✓	✓	✓	✓	✓	✓	✓	✓	✓	✓	✓	✓	✓	✓	✓	✓	✓	✓	✓	✓	✓	✓	✓	✓	✓	✓						
D4		✓											✓	✓	✓	✓			✓	✓	✓	✓	✓	✓	✓	✓	✓	✓	✓	✓	✓	✓						
D7		✓	✓										✓	✓	✓	✓			✓	✓	✓	✓	✓	✓	✓	✓	✓	✓	✓	✓	✓	✓						
PDA		✓	✓					✓				✓	✓	✓	✓	✓			✓	✓	✓	✓	✓	✓	✓	✓	✓	✓	✓	✓	✓	✓						
PDD		✓	✓					✓				✓	✓	✓	✓	✓			✓	✓	✓	✓	✓	✓	✓	✓	✓	✓	✓	✓	✓	✓						
PDS		✓	✓					✓				✓	✓	✓	✓	✓			✓	✓	✓	✓	✓	✓	✓	✓	✓	✓	✓	✓	✓	✓						
LDA		✓						✓				✓	✓	✓	✓	✓			✓	✓	✓	✓	✓	✓	✓	✓	✓	✓	✓	✓	✓	✓						
LDD		✓						✓				✓	✓	✓	✓	✓			✓	✓	✓	✓	✓	✓	✓	✓	✓	✓	✓	✓	✓	✓						
LDS		✓						✓				✓	✓	✓	✓	✓			✓	✓	✓	✓	✓	✓	✓	✓	✓	✓	✓	✓	✓	✓						
GDA		✓						✓				✓	✓	✓	✓	✓			✓	✓	✓	✓	✓	✓	✓	✓	✓	✓	✓	✓	✓	✓						
GDD		✓						✓				✓	✓	✓	✓	✓			✓	✓	✓	✓	✓	✓	✓	✓	✓	✓	✓	✓	✓	✓						
GDS		✓						✓				✓	✓	✓	✓	✓			✓	✓	✓	✓	✓	✓	✓	✓	✓	✓	✓	✓	✓	✓						



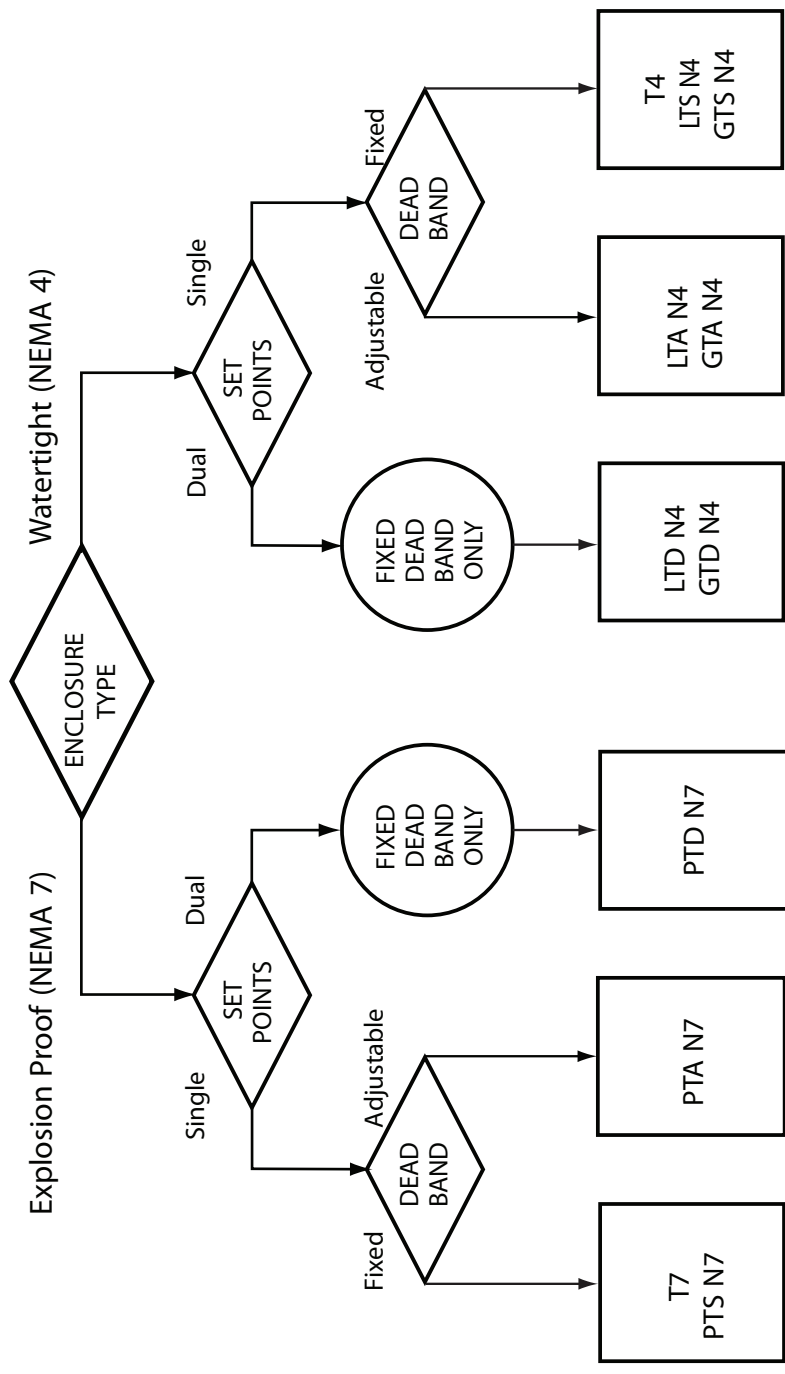







TEMPERATURE SWITCH SELECTION



- 1.
- 2.
- 3.
- 4.
5. Determine the operation range needed from the appropriate switch model range charts.
6. Select the appropriate micro switch based on your electrical requirements and dead band requirements.
7. Select the wetted materials and process connection based on your process media and piping.

At this point you should be able to build the appropriate switch part number by following the "How to order this switch" section on the appropriate catalog page. Additional switch options should also be added to the part number.

TEMPERATURE PRESSURE SWITCH PRODUCT MATRIX

		ENCLOSURE / PROCESS INPUT			CONTROL FUNCTION			SWITCH TYPE			WETTED MATERIAL			RANGES																					
		Watertight (NEMA 4)	Explosion Proof (Nema 7)	Stainless Steel Body	Pressure	Differential Pressure	Temperature	Single Fixed Setpoint	Single Adjustable Setpoint	Adjustable Deadband	Two Indep. Adjust. Setpoints	Fixed Deadband	General Purpose	Narrow Deadband	Hermetically Sealed	Manual Reset	Relay	DPDT	Buna	Viton	Teflon	Stainless Steel	Monel	Vacuum	Compound Inches of Water	Inches of Water	Compound	0-400 psi	0-600 psi	1000 psi	2000 psi	3000 psi	4000 psi	5000-20,000 psi	-40-750°F
	T4	✓	✓	✓			✓	✓				✓	✓	✓	✓							✓												✓	
	T7	✓	✓	✓			✓	✓				✓	✓	✓	✓							✓												✓	
	PTA	✓	✓				✓		✓				✓	✓	✓							✓												✓	
	PTD	✓	✓				✓					✓	✓	✓	✓							✓												✓	
	PTS	✓	✓				✓	✓				✓	✓	✓	✓							✓												✓	
	LTA	✓					✓	✓				✓	✓	✓	✓							✓												✓	
	LTD	✓					✓					✓	✓	✓	✓							✓												✓	
	LTS	✓					✓	✓				✓	✓	✓	✓							✓												✓	
	GTA	✓		✓			✓	✓				✓	✓	✓	✓							✓												✓	
	GTD	✓		✓			✓					✓	✓	✓	✓							✓												✓	
	GTS	✓		✓			✓					✓	✓	✓	✓							✓												✓	